

Features

- Third Generation Programmable Logic Structure
High Density Replacement for Discrete Logic
- High Speed - Plus a New Low Power Version
- Increased Logic Flexibility
42 Inputs and 20 Sum terms
- Flexible Output Logic
20 Flip-Flops - 10 Extra
All Can Be Individually Buried or 10 Output Directly
Each has Individual Asynchronous Reset and Clock Terms
- Multiple Feedback Paths Provide for Buried State Machines and I/O Bus Compatibility
- Proven and Reliable High Speed CMOS EPROM Process
2000 V ESD Protection
200 mA Latchup Immunity
- Reprogrammable - Tested 100% for Programmability
- 24-pin, 300-mil Dual-In-line and 28-Lead Surface Mount Packages

1

**High Density
UV Erasable
Programmable
Logic Device**

Logic Diagram

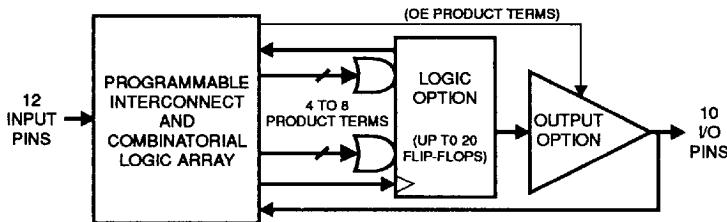

Description

The ATV750/L is 100% more powerful than most other programmable logic devices in 24-pin packages. Increased product terms, sum terms, and flip-flops translate into more usable gates.

Each of the ATV750's 22 logic pins can be used as an input. Ten of these can be used as input, output, or bi-directional I/O pins. All 20 flip-flops can be fed back into the array independently. This flexibility allows burying all of the sum terms and flip-flops.

There are 171 product terms available. A variable format is used to assign between four and eight product terms per sum term. There are two sum terms per output, providing added flexibility.

The ATV750/L has more flip-flops available than other PLDs in this density range. Complex state machines are easily implemented.

Product terms are available providing asynchronous resets, flip-flop clocks, and output enables. One reset and one clock term are provided per flip-flop, with one enable term per output. One product term provides a global synchronous preset. Register preload simplifies testing. The device has an internal power up clear function.

Pin Configurations

| Pin Name | Function |
|----------|------------------------|
| IN | Logic Inputs |
| I/O | Bidirectional Buffers |
| * | No Internal Connection |
| Vcc | +5V Supply |

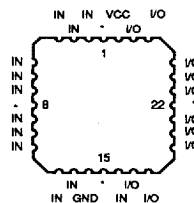
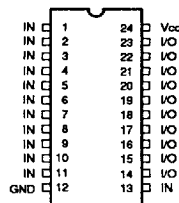

1074177 0007227 T92

Absolute Maximum Ratings*

| | |
|---|----------------------------------|
| Temperature Under Bias..... | -55°C to +125°C |
| Storage Temperature..... | -65°C to +150°C |
| Voltage on Any Pin with Respect to Ground..... | -2.0 V to +7.0 V ⁽¹⁾ |
| Voltage on Input Pins with Respect to Ground During Programming | -2.0 V to +14.0 V ⁽¹⁾ |
| Programming Voltage with Respect to Ground..... | -2.0 V to +14.0 V ⁽¹⁾ |
| Integrated UV Erase Dose | 7258 W. sec/cm ² |

*NOTICE: Stresses beyond those listed under "Absolute Maximum Ratings" may cause permanent damage to the device. This is a stress rating only and functional operation of the device at these or any other conditions beyond those indicated in the operational sections of this specification is not implied. Exposure to absolute maximum rating conditions for extended periods may affect device reliability.

Note:

1. Minimum voltage is -0.6 V dc which may undershoot to -2.0 V for pulses of less than 20 ns. Maximum output pin voltage is $V_{CC}+0.75$ V dc which may overshoot to +7.0 V for pulses of less than 20 ns.

Logic Options

Combined Terms

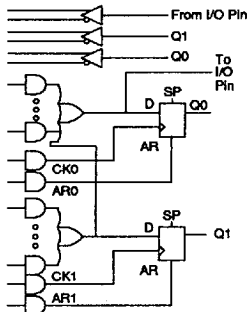

Separate Terms

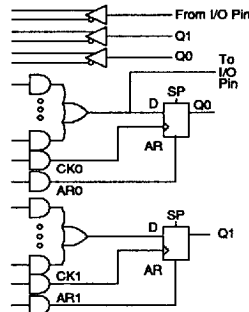

Combined Terms

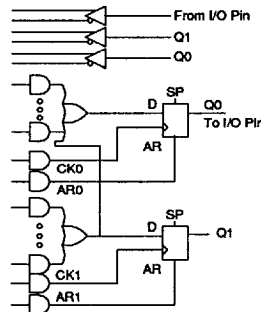

Separate Terms

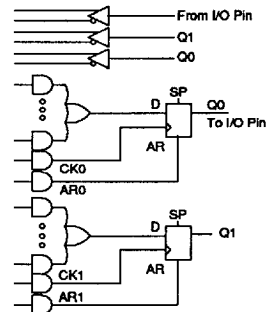

Output Options

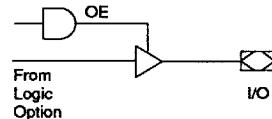
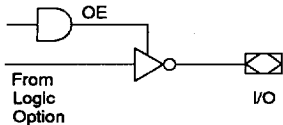

D.C. and A.C. Operating Conditions

| | | ATV750-20 | ATV750/L-25 | ATV750/L-30 | ATV750-35 |
|------------------------------|------|---------------|---------------|---------------|---------------|
| Operating Temperature (Case) | Com. | 0°C - 70°C | 0°C - 70°C | 0°C - 70°C | 0°C - 70°C |
| | Ind. | -40°C - 85°C | -40°C - 85°C | -40°C - 85°C | -40°C - 85°C |
| | Mil. | -55°C - 125°C | -55°C - 125°C | -55°C - 125°C | -55°C - 125°C |
| V _{CC} Power Supply | | 5 V ± 10% | 5 V ± 10% | 5 V ± 10% | 5 V ± 10% |

D.C. Characteristics

| Symbol | Parameter | Condition | Min | Typ | Max | Units | |
|----------------------|------------------------------|---|-----------------------------------|----------------------|-----------------------|-------|----|
| I _{LI} | Input Load Current | V _{IN} = -0.1 V to V _{CC} +1 V | | | 10 | μA | |
| I _{LO} | Output Leakage Current | V _{OUT} = -0.1 V to V _{CC} +0.1 V | | | 10 | μA | |
| I _{CC} | Power Supply Current | V _{CC} = MAX , V _{IN} = GND, Outputs Open | ATV750 | Com. | | 120 | mA |
| | | | | Ind.,Mil. | | 140 | mA |
| | | | ATV750L | Com. | 1.0 | 12 | mA |
| | | | | Ind.,Mil. | 1.0 | 15 | mA |
| I _{CC2} (2) | Clocked Power Supply Current | f = 1MHz, V _{CC} = MAX, Outputs Open | ATV750L | Com. | | 15 | mA |
| | | | | Ind.,Mil. | | 20 | mA |
| I _{OS} (1) | Output Short Circuit Current | V _{OUT} = 0.5 V | | | -90 | mA | |
| V _{IL} | Input Low Voltage | | -0.6 | | 0.8 | V | |
| V _{IH} | Input High Voltage | | 2.0 | | V _{CC} +0.75 | V | |
| V _{OL} | Output Low Voltage | V _{IN} = V _{IH} or V _{IL} , V _{CC} = MIN | I _{OL} = 12 mA Com.,Ind. | | 0.5 | V | |
| | | | I _{OL} = 8 mA Mil. | | 0.5 | V | |
| | | | I _{OL} = 24 mA, Com. | | 1.0 | V | |
| V _{OH} | Output High Voltage | V _{IN} = V _{IH} or V _{IL} , V _{CC} = MIN | I _{OH} = -100 μA | V _{CC} -0.3 | | V | |
| | | | I _{OH} = -4.0 mA | 2.4 | | V | |

Notes: 1. Not more than one output at a time should be shorted. Duration of short circuit test should not exceed 30 sec. 2. Outputs not loaded.



1074177 0007229 865

A.C. Waveforms ⁽¹⁾

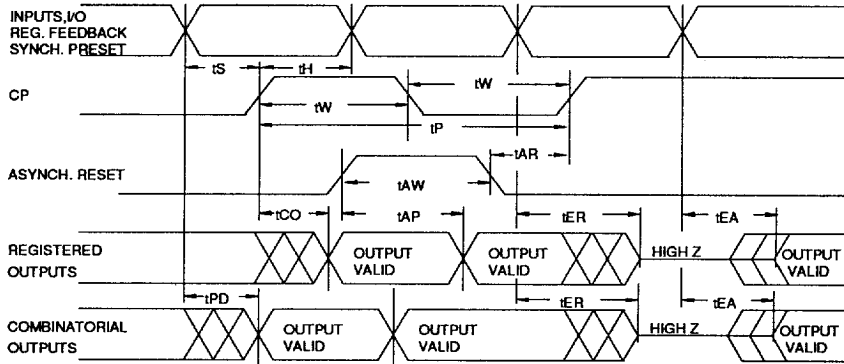

Note: 1. Timing measurement reference is 1.5 V. Input AC driving levels are 0.0 V and 3.0 V, unless otherwise specified.

A.C. Characteristics

| Symbol | Parameter | ATV750-30 | | ATV750-35 | | Units |
|-----------|---|-----------|-----|-----------|-----|-------|
| | | Min | Max | Min | Max | |
| t_{PD} | Input or Feedback to Non-Registered Output | | 30 | | 35 | ns |
| t_{EA} | Input to Output Enable | | 30 | | 35 | ns |
| t_{ER} | Input to Output Disable | | 30 | | 35 | ns |
| t_{CO} | Clock to Output | 5 | 25 | 10 | 30 | ns |
| t_{CF} | Clock to Feedback | 5 | 10 | 10 | 12 | ns |
| t_s | Input Setup Time | 15 | | 18 | | ns |
| t_H | Hold Time | 5 | | 10 | | ns |
| t_P | Clock Period | 25 | | 30 | | ns |
| t_W | Clock Width | 12 | | 15 | | ns |
| F_{MAX} | Maximum Frequency | | 40 | | 33 | MHz |
| t_{AW} | Asynchronous Reset Width | 30 | | 35 | | ns |
| t_{AR} | Asynchronous Reset Recovery Time | 30 | | 35 | | ns |
| t_{AP} | Asynchronous Reset to Registered Output Reset | | 30 | | 35 | ns |
| t_{SP} | Setup Time, Synchronous Preset | 15 | | 18 | | ns |

A.C. Characteristics

| Symbol | Parameter | ATV750-20 | | ATV750/L-25 | | ATV750L-30 | | Units |
|------------------|---|-----------|-----|-------------|-----|------------|-----|-------|
| | | Min | Max | Min | Max | Min | Max | |
| t _{PD} | Input or Feedback to Non-Registered Output | | 20 | | 25 | | 30 | ns |
| t _{EA} | Input to Output Enable | | 20 | | 25 | | 30 | ns |
| t _{ER} | Input to Output Disable | | 20 | | 25 | | 30 | ns |
| t _{CO} | Clock to Output | | 20 | | 22 | 5 | 25 | ns |
| t _{CF} | Clock to Feedback | 5 | 10 | 5 | 10 | 5 | 10 | ns |
| t _S | Input Setup Time | 10 | | 12 | | 15 | | ns |
| t _{SF} | Feedback Setup Time | 5 | | 7 | | 15 | | ns |
| t _H | Hold Time | 5 | | 5 | | 5 | | ns |
| t _P | Clock Period | 18 | | 22 | | 25 | | ns |
| t _W | Clock Width | 8 | | 10 | | 12 | | ns |
| f _{MAX} | Maximum Frequency | | 55 | | 45 | | 40 | MHz |
| t _{AW} | Asynchronous Reset Width | 15 | | 20 | | 30 | | ns |
| t _{AR} | Asynchronous Reset Recovery Time | 15 | | 20 | | 30 | | ns |
| t _{AP} | Asynchronous Reset to Registered Output Reset | | 20 | | 25 | | 30 | ns |
| t _{SP} | Setup Time, Synchronous Preset | 12 | | 15 | | 15 | | ns |

Input Test Waveforms and Measurement Levels

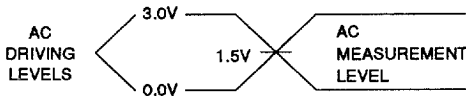

t_R, t_F < 5 ns (10% to 90%)

Output Test Load

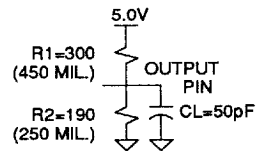

1074177 0007231 413



Functional Logic Diagram ATV750, Upper Half

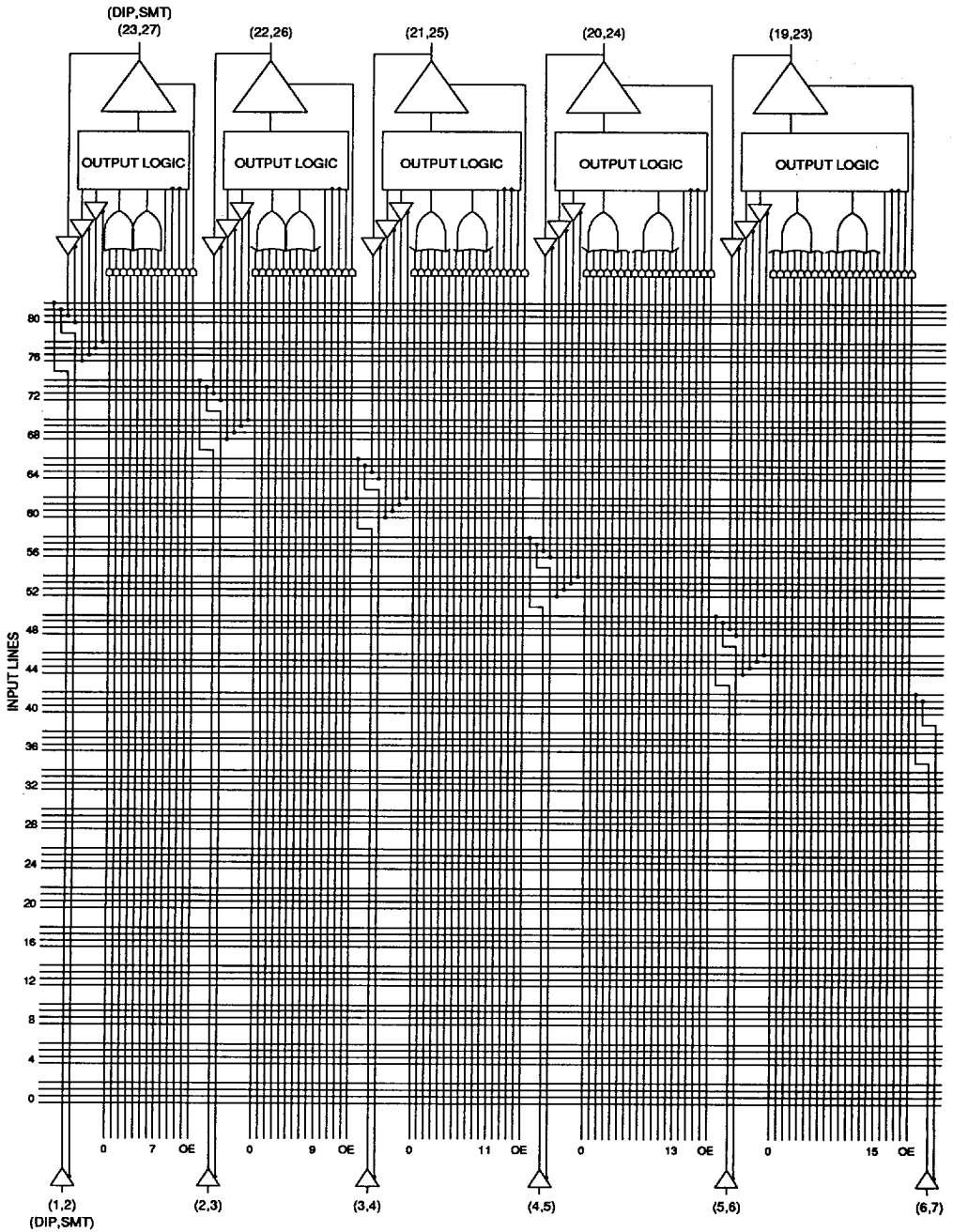

1-104

ATV750/L

1074177 0007232 35T

Functional Logic Diagram ATV750, Lower Half

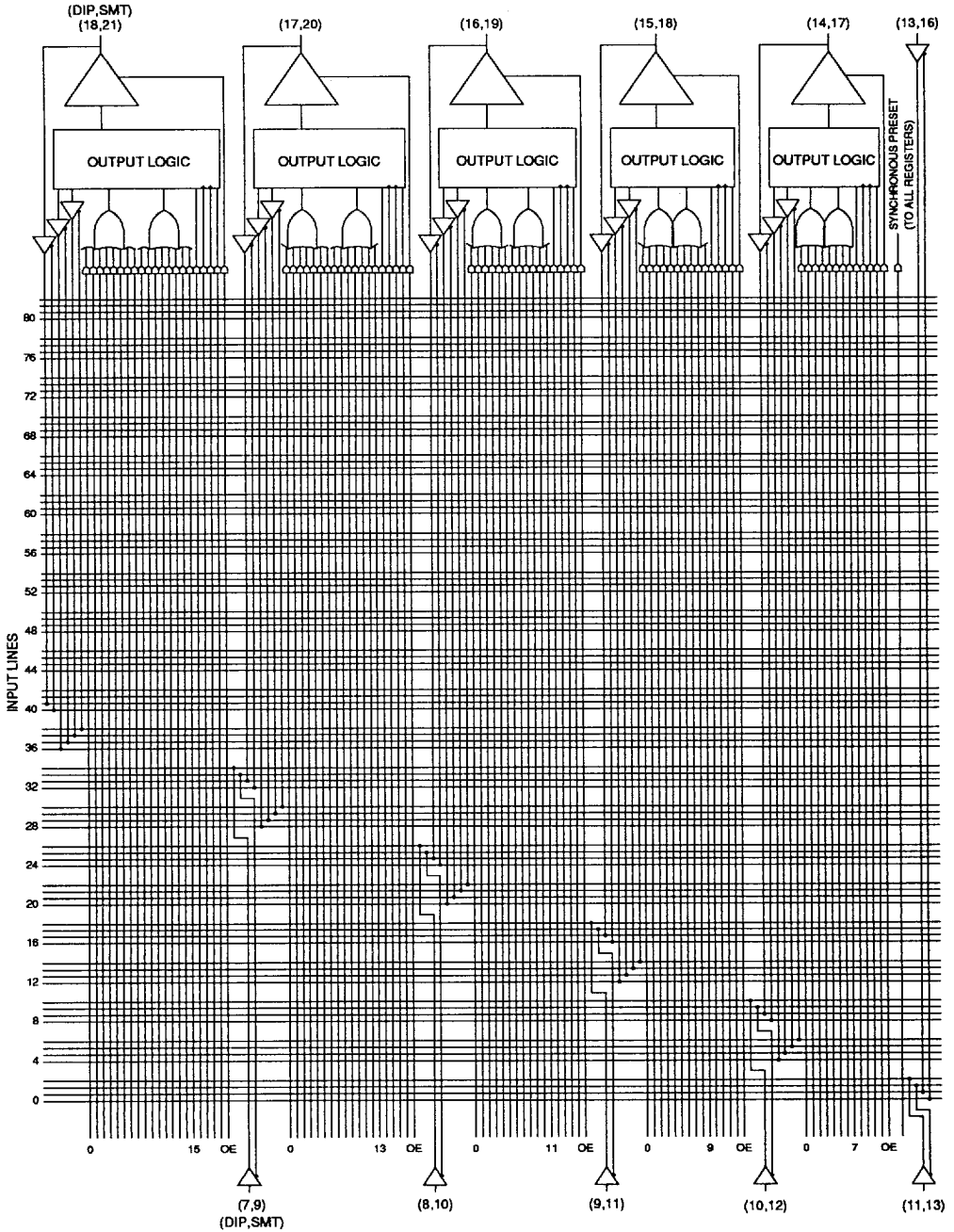

1



1074177 0007233 296



Preload of Registered Outputs

The ATV750's registers are provided with circuitry to allow loading of each register asynchronously with either a high or a low. This feature will simplify testing since any state can be forced into the registers to control test sequencing. A V_{IH} level on the I/O pin will force the register high; a V_{IL} will force it low,

independent of the output polarity. The preload state is entered by placing an 10.5-V to 11.5-V signal on pin 8 on DIPs, and pin 10 on SMPs. When the clock term is pulsed high, the data on the I/O pin is placed into the register chosen by the Select Pin.

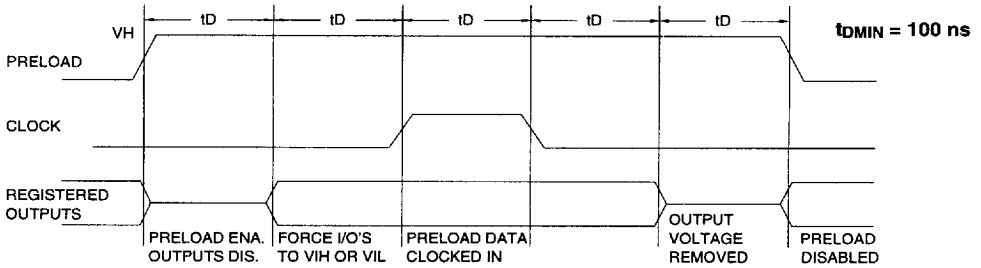

| Level forced on registered output pin during PRELOAD cycle | Select Pin State | Register #1 state after cycle | Register #2 State after cycle |
|--|------------------|-------------------------------|-------------------------------|
| V_{IH} | Low | High | X |
| V_{IL} | Low | Low | X |
| V_{IH} | High | X | High |
| V_{IL} | High | X | Low |

Power Up Reset

The registers in the ATV750/L are designed to reset during power up. At a point delayed slightly from V_{CC} crossing 3.8 V, all registers will be reset to the low state. The output state will depend on the polarity of the output buffer.

This feature is critical for state machine initialization. However, due to the asynchronous nature of reset and the uncertainty of how V_{CC} actually rises in the system, the following conditions are required:

- 1) The V_{CC} rise must be monotonic,
- 2) After reset occurs, all input and feedback setup times must be met before driving the clock term high, and
- 3) The signals from which the clock is derived must remain stable during t_{PR} .

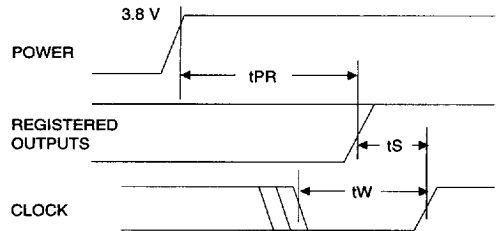

| Parameter | Description | Min | Typ | Max | Units |
|-----------|---------------------|-----|-----|------|-------|
| t_{PR} | Power-Up Reset Time | | 600 | 1000 | ns |

Pin Capacitance (f = 1 MHz, T = 25°C) ⁽¹⁾

| | Typ | Max | Units | Conditions |
|-----------|-----|-----|-------|-----------------|
| C_{IN} | 5 | 8 | pF | $V_{IN} = 0 V$ |
| C_{OUT} | 6 | 8 | pF | $V_{OUT} = 0 V$ |

Note: 1. Typical values for nominal supply voltage. This parameter is only sampled and is not 100% tested.

Using the ATV750's Many Advanced Features

The ATV750's flexibility puts more usable gates in 24 pins than other PLDs. The ATV750/L starts with an architecture similar to the popular AT22V10, and adds several features:

- **Asynchronous Clocks** -
Each of the flip-flops in the ATV750/L has a dedicated product term driving the clock. The user is no longer constrained to using one clock for all the registers. Buried state machines, counters, and registers can all coexist in one device, while running on separate clocks. The ATV750/L clock period matches that of similar synchronous devices.
- **A Full Bank of 10 More Registers** -
The ATV750/L provides two flip-flops for each output macrocell - a total of 20. Each register has its own clock and reset product terms, as well as its own SUM term.
- **Independent I/O Pin and Feedback Paths** -
Each I/O pin on the ATV750/L has a dedicated input path. Each of the 20 registers has individual feedback terms into the array. This feature, combined with individual product terms for each I/O's output enable, facilitates designs using bi-directional I/O buses.
- **Combinable Sum Terms** -
Each output macrocell's two SUM terms can be combined in an OR gate before the output or the register. This provides up to 16 product terms per output or flip-flop. This architecture increases the number of usable gates available.

Programming Software Support

Software which is capable of transforming Boolean equations, state machine descriptions and truth tables into JEDEC files for the ATV750/L is available from several PLD software vendors. Please refer to the Software Support Information table in the *Programmable Logic Development Tools* section for more information.

Synchronous Preset and Asynchronous Reset

One synchronous preset line is provided for all 20 registers in the ATV750/L. The appropriate input signals to cause the internal clocks to go to a high state must be received during a synchronous preset. Appropriate setup and hold times must be met, as shown in the switching waveform diagram.

An individual asynchronous reset line is provided for each of the 20 flip-flops. Both master and slave halves of the flip-flops are reset when the input signals received combine so as to force the internal resets high.

Security Fuse Usage

A single fuse is provided to prevent unauthorized copying of the ATV750/L fuse patterns. Once programmed, the output buffers will remain in a high impedance state during verify.

The security fuse should be programmed last, as its effect is immediate.

Erase Characteristics

The entire memory array of an ATV750/L is erased after exposure to ultraviolet light at a wavelength of 2537 Å. Complete erasure is assured after a minimum of 20 minutes exposure using 12,000 $\mu\text{W}/\text{cm}^2$ intensity lamps spaced one inch away from the chip. Minimum erase time for lamps at other intensity ratings can be calculated from the minimum integrated erasure dose of 15 $\text{W}\cdot\text{sec}/\text{cm}^2$. To prevent unintentional erasure, an opaque label is recommended to cover the clear window on any UV erasable PLD which will be subjected to continuous fluorescent indoor lighting or sunlight.

Atmel CMOS PLDs

Atmel's Programmable Logic Devices utilize an advanced 1.5-micron CMOS EPROM technology. This technology's state of the art features are the optimum combination for PLDs:

- CMOS technology provides high speed, low power, and high noise immunity.
- EPROM technology is the most cost effective method for producing PLDs - surpassing bipolar fusible link technology in low cost, while providing the necessary reprogrammability.
- EPROM reprogrammability, which is 100% tested before shipment, provides inherently better programmability and reliability than one-time fusible PLDs.
- Atmel's EPROM process has proven extremely reliable in the volume production of a full line of advanced EPROM memory products, from 64K to one-megabit devices.





V750 ICC vs FREQUENCY
TA = 25C, VCC = 5V

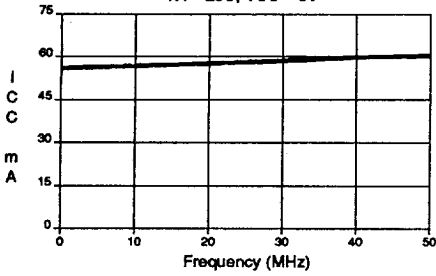

V750L ICC vs FREQUENCY
TA = 25C, VCC = 5V

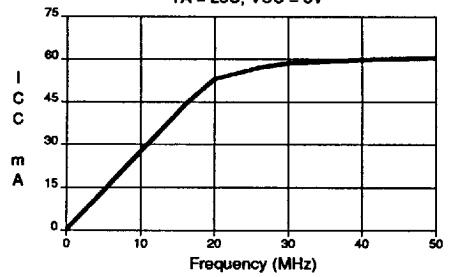

NORMALIZED ICC vs. VCC
TA = 25C, f = 30 MHz

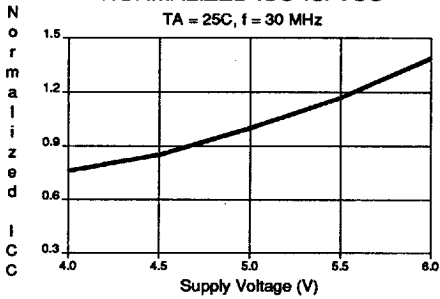

NORMALIZED ICC vs. AMBIENT TEMP.
f = 30 MHz, VCC = 5V

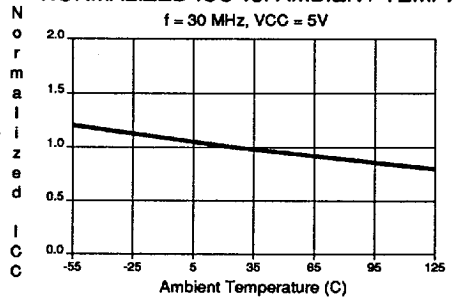

Ordering Information

| tpd (ns) | tco (ns) | fMAX (MHz) | Ordering Code | Package | Operation Range |
|-----------------|----------|---|---------------|-------------------------------|-----------------------------|
| 20 | 20 | 55 | ATV750-20DC | 24DW3 | Commercial (0°C to 70°C) |
| | | | ATV750-20GC | 24D3 | |
| | | | ATV750-20JC | 28J | |
| | | | ATV750-20KC | 28KW | |
| | | | ATV750-20LC | 28LW | |
| | | | ATV750-20NC | 28L | |
| | | | ATV750-20PC | 24P3 | |
| | | | ATV750-20SC | 24S | |
| | | ATV750-20DI | 24DW3 | Industrial (-40°C to 85°C) | |
| | | ATV750-20GI | 24D3 | | |
| | | ATV750-20JI | 28J | | |
| | | ATV750-20KI | 28KW | | |
| | | ATV750-20LI | 28LW | | |
| | | ATV750-20NI | 28L | | |
| | | ATV750-20PI | 24P3 | | |
| | | ATV750-20SI | 24S | | |
| ATV750-20DM | 24DW3 | Military (-55°C to 125°C) | | | |
| ATV750-20GM | 24D3 | | | | |
| ATV750-20KM | 28KW | | | | |
| ATV750-20LM | 28LW | | | | |
| ATV750-20NM | 28L | | | | |
| ATV750-20DM/883 | 24DW3 | Military/883C (-55°C to 125°C) Class B, Fully Compliant | | | |
| ATV750-20GM/883 | 24D3 | | | | |
| ATV750-20KM/883 | 28KW | | | | |
| ATV750-20LM/883 | 28LW | | | | |
| ATV750-20NM/883 | 28L | | | | |
| 25 | 22 | 45 | ATV750-25DC | 24DW3 | Commercial (0°C to 70°C) |
| | | | ATV750-25GC | 24D3 | |
| | | | ATV750-25JC | 28J | |
| | | | ATV750-25KC | 28KW | |
| | | | ATV750-25LC | 28LW | |
| | | ATV750-25NC | 28L | | |
| | | ATV750-25PC | 24P3 | | |
| | | ATV750-25SC | 24S | | |
| | | ATV750-25DI | 24DW3 | Industrial (-40°C to 85°C) | |
| | | ATV750-25GI | 24D3 | | |
| ATV750-25JI | 28J | | | | |
| ATV750-25KI | 28KW | | | | |
| ATV750-25LI | 28LW | | | | |
| ATV750-25NI | 28L | | | | |
| ATV750-25PI | 24P3 | | | | |
| ATV750-25SI | 24S | | | | |

1



1074177 0007237 931



Ordering Information

| t _{PD} (ns) | t _{CO} (ns) | f _{MAX} (MHz) | Ordering Code | Package | Operation Range |
|-------------------------|-------------------------|---------------------------|---|--------------------------------------|---|
| 25 | 22 | 45 | ATV750-25DM/883 ATV750-25GM/883 ATV750-25KM/883 ATV750-25LM/883 ATV750-25NM/883 | 24DW3 24D3 28KW 28LW 28L | Military/883C (-55°C to 125°C) Class B, Fully Compliant |
| 20 | 20 | 55 | 5962-88726 04 LX 5962-88726 04 3X | 24DW3 28LW | Military/883C (-55°C to 125°C) Class B, Fully Compliant |
| 25 | 22 | 45 | 5962-88726 03 LX 5962-88726 03 3X | 24DW3 28LW | Military/883C (-55°C to 125°C) Class B, Fully Compliant |

1-110

ATV750/L

1074177 0007238 878

Ordering Information

| tpd (ns) | tco (ns) | fMAX (MHz) | Ordering Code | Package | Operation Range |
|----------|----------|------------|--|--|---|
| 25 | 22 | 45 | ATV750L-25DC ATV750L-25GC ATV750L-25JC ATV750L-25KC ATV750L-25LC ATV750L-25NC ATV750L-25PC ATV750L-25SC | 24DW3 24D3 28J 28KW 28LW 28L 24P3 24S | Commercial (0°C to 70°C) |
| | | | ATV750L-25DI ATV750L-25GI ATV750L-25JI ATV750L-25KI ATV750L-25LI ATV750L-25NI ATV750L-25PI ATV750L-25SI | 24DW3 24D3 28J 28KW 28LW 28L 24P3 24S | Industrial (-40°C to 85°C) |
| | | | ATV750L-25DM ATV750L-25GM ATV750L-25KM ATV750L-25LM ATV750L-25NM | 24DW3 24D3 28KW 28LW 28L | Military (-55°C to 125°C) |
| | | | ATV750L-25DM/883 ATV750L-25GM/883 ATV750L-25KM/883 ATV750L-25LM/883 ATV750L-25NM/883 | 24DW3 24D3 28KW 28LW 28L | Military/883C (-55°C to 125°C) Class B, Fully Compliant |
| 25 | 22 | 45 | 5962-88726 07 LX 5962-88726 07 3X | 24DW3 28LW | Military/883C (-55°C to 125°C) Class B, Fully Compliant |

Package Type

| | |
|--------------|---|
| 24DW3 | 24 Lead, 0.300" Wide, Windowed, Ceramic Dual Inline Package (Cerdip) |
| 24D3 | 24 Lead, 0.300" Wide, Non-Windowed (OTP) Ceramic Dual Inline Package (Cerdip) |
| 28J | 28 Lead, Plastic J-Leaded Chip Carrier OTP (PLCC) |
| 28KW | 28 Lead, Windowed, Ceramic J-Leaded Chip Carrier (JLCC) |
| 28LW | 28 Pad, Windowed, Ceramic Leadless Chip Carrier (LCC) |
| 28L | 28 Pad, Non-Windowed, Ceramic Leadless Chip Carrier OTP (LCC) |
| 24P3 | 24 Lead, 0.300" Wide, Plastic Dual Inline Package OTP (PDIP) |
| 24S | 24 Lead, 0.300" Wide, Plastic Gull Wing Small Outline OTP (SOIC) |



1074177 0007239 704